

Das ist Ahtilla Ot
Sie ist eine Frau.

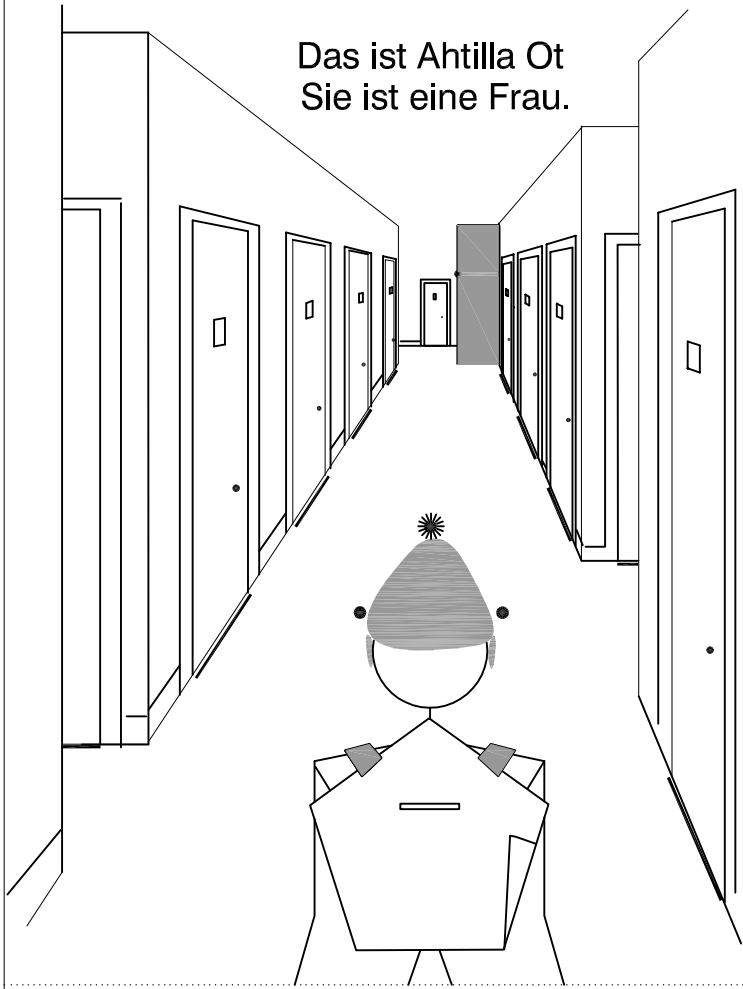

The rent here
is cheap.

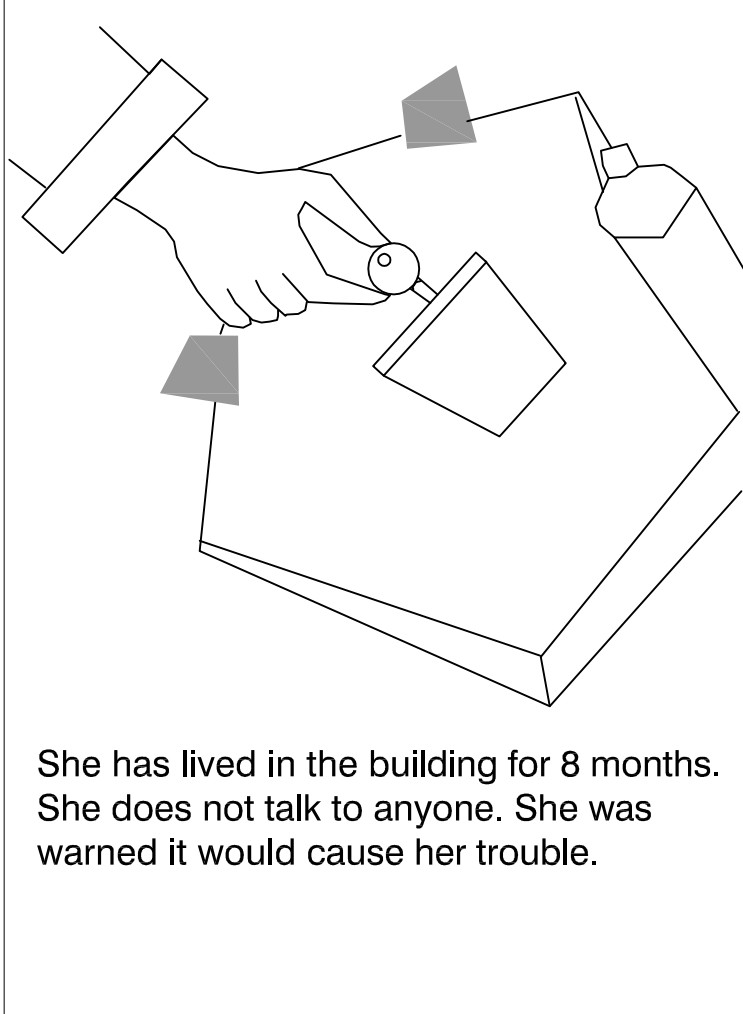

She has lived in the building for 8 months.
She does not talk to anyone. She was
warned it would cause her trouble.

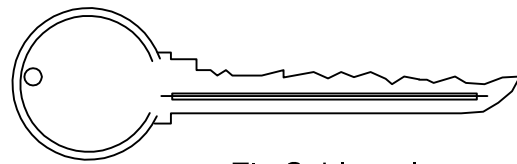

Ein Schlüssel

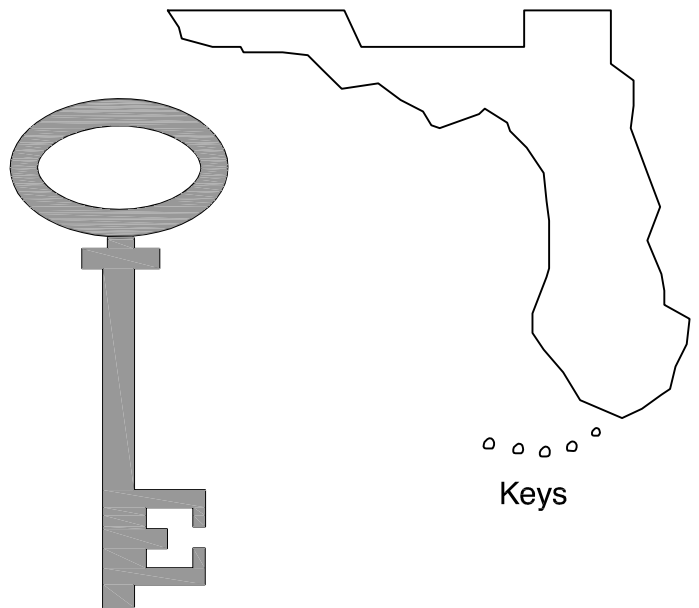

Keys

Childhood Key

She is an illegal
sublet.

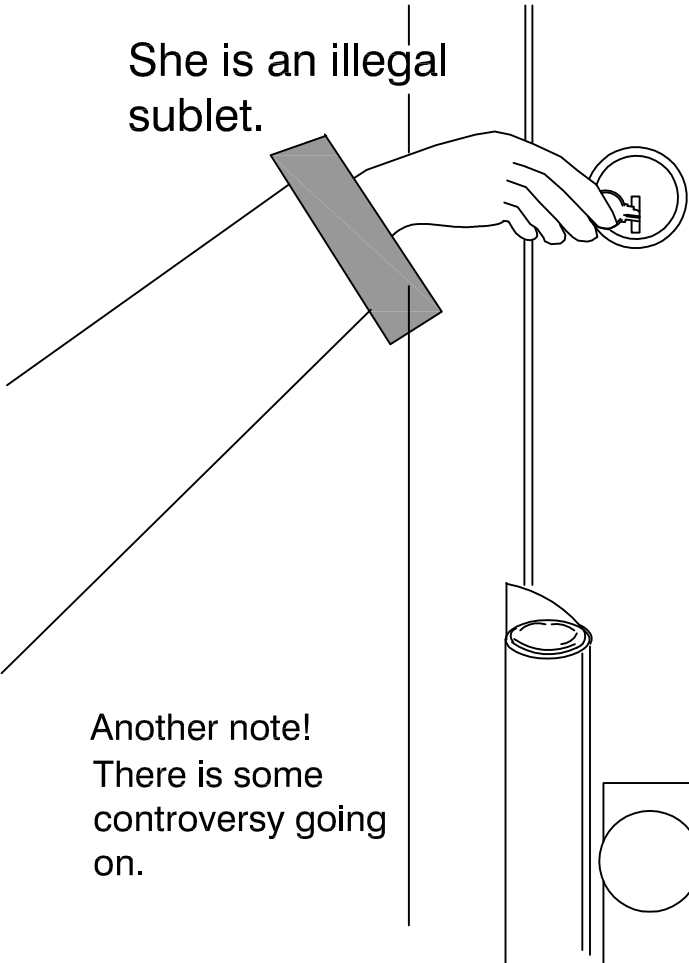

Another note!
There is some
controversy going
on.

She refuses to
read them.

This is her way -
one of many -
to stay....

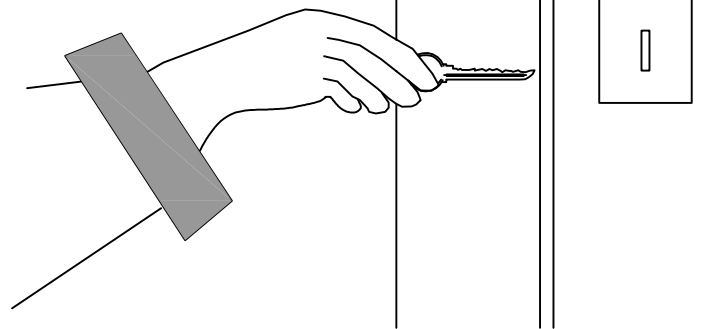

...invisible.

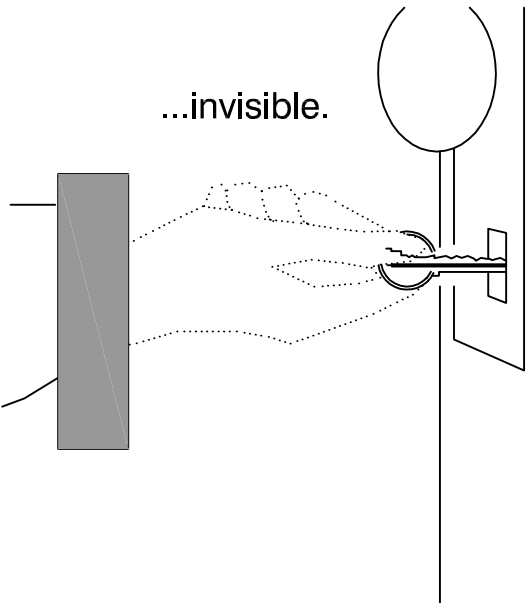

Jetzt ist der Schlüssel im
Schlüsselloch.

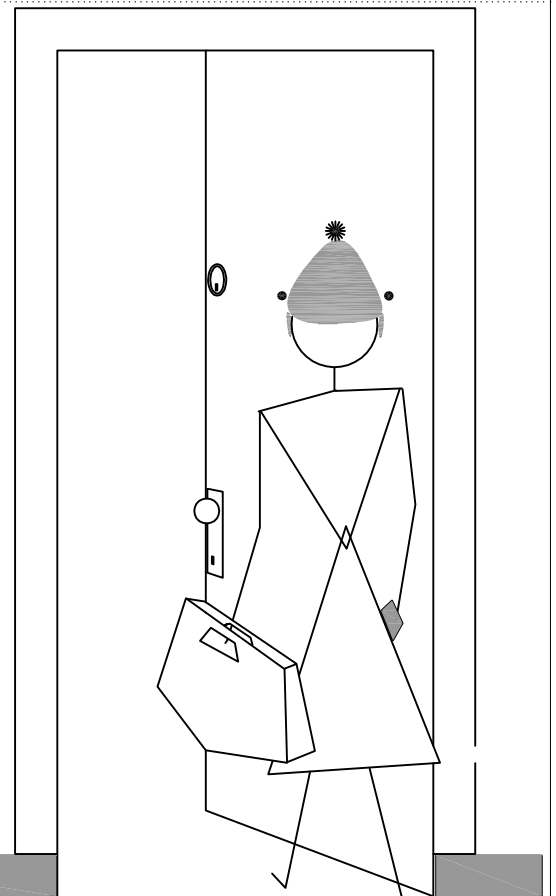

Someone in the hallway!
She quickly enters.

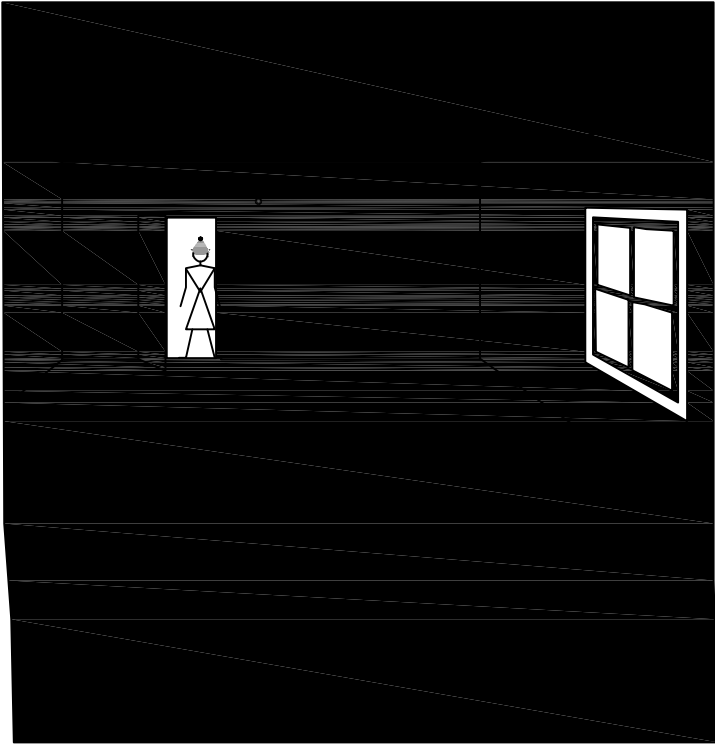

Ihr Haus.

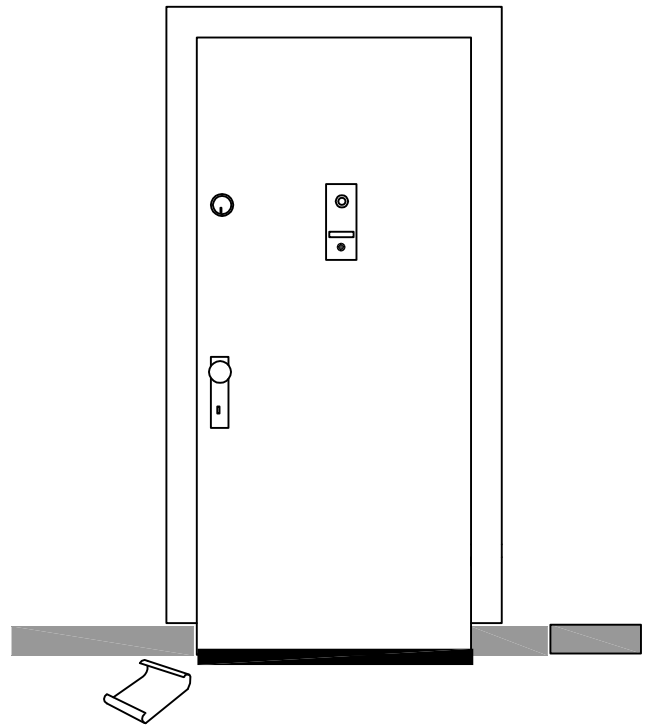

In her haste, she does not see the note has fallen to the floor. Tsk tsk says the neighbor. Such a slob.

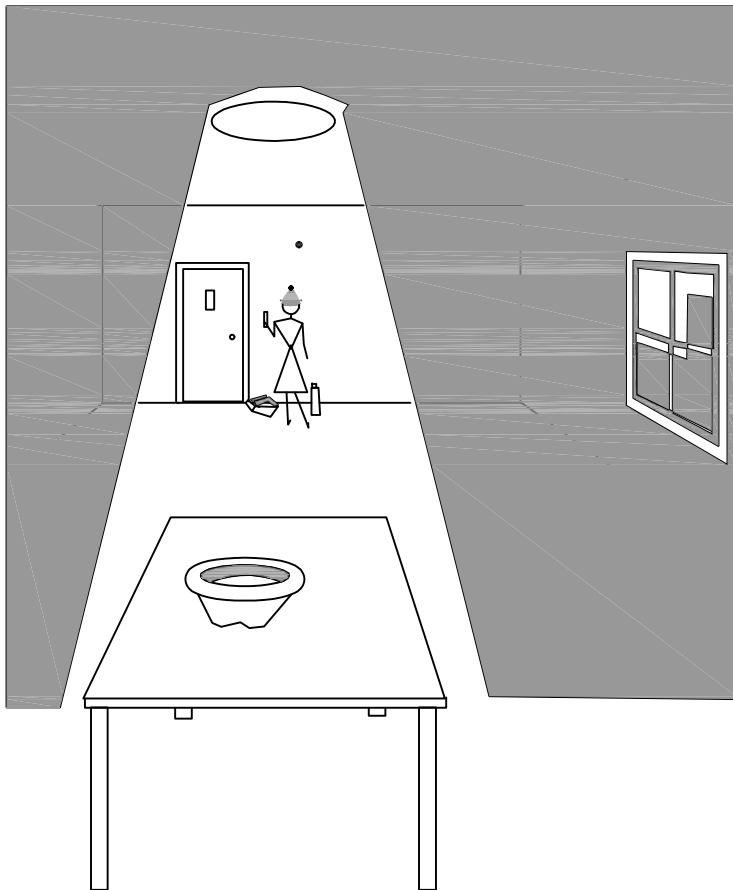

She turns on the light. Ein Hut!

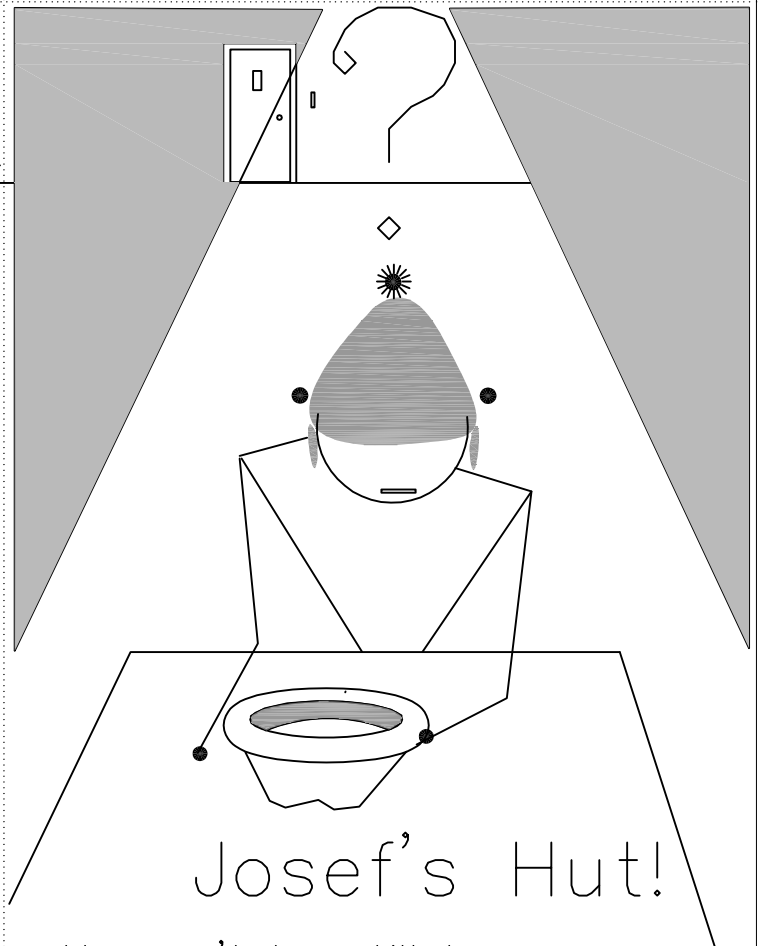

He can't be still here.

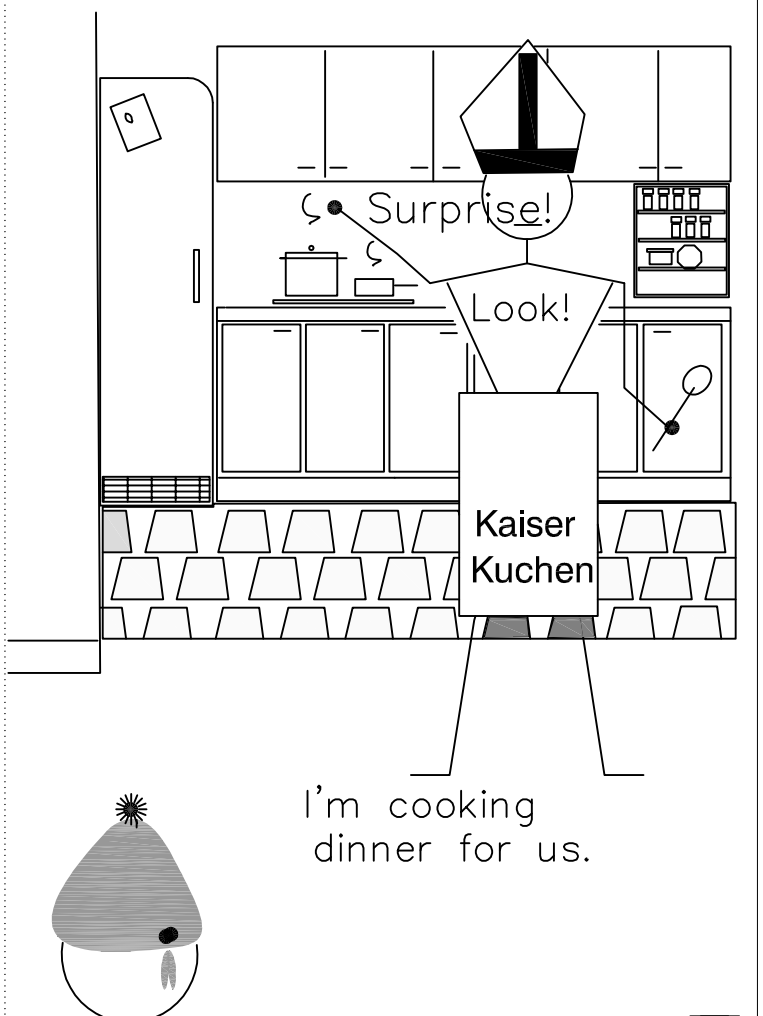
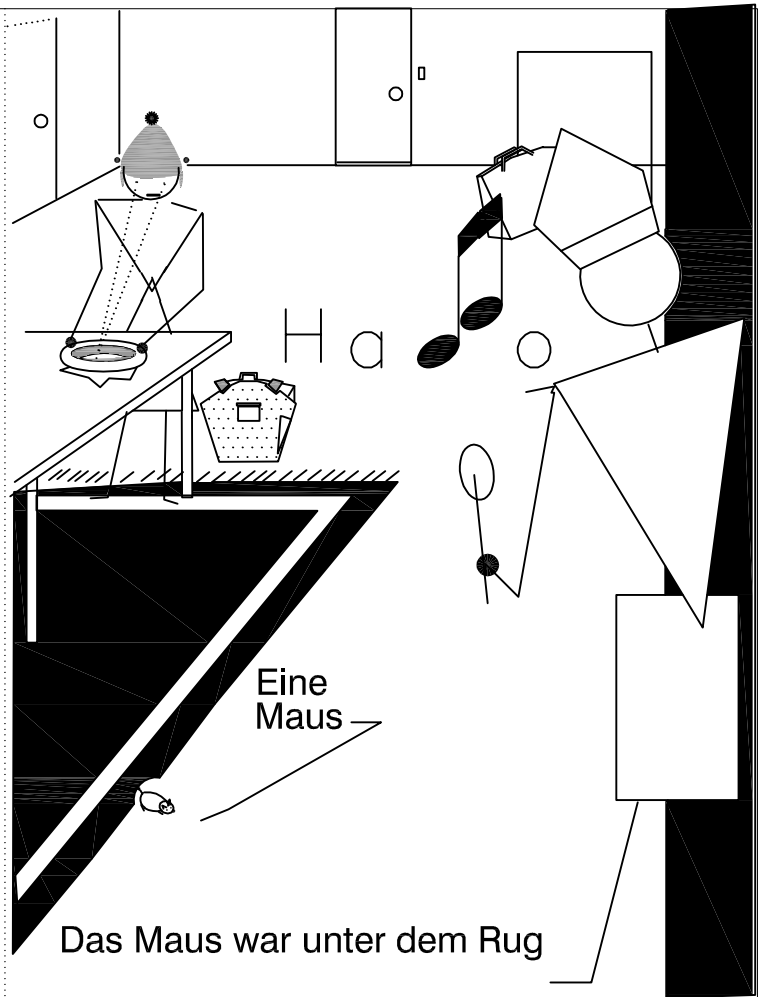

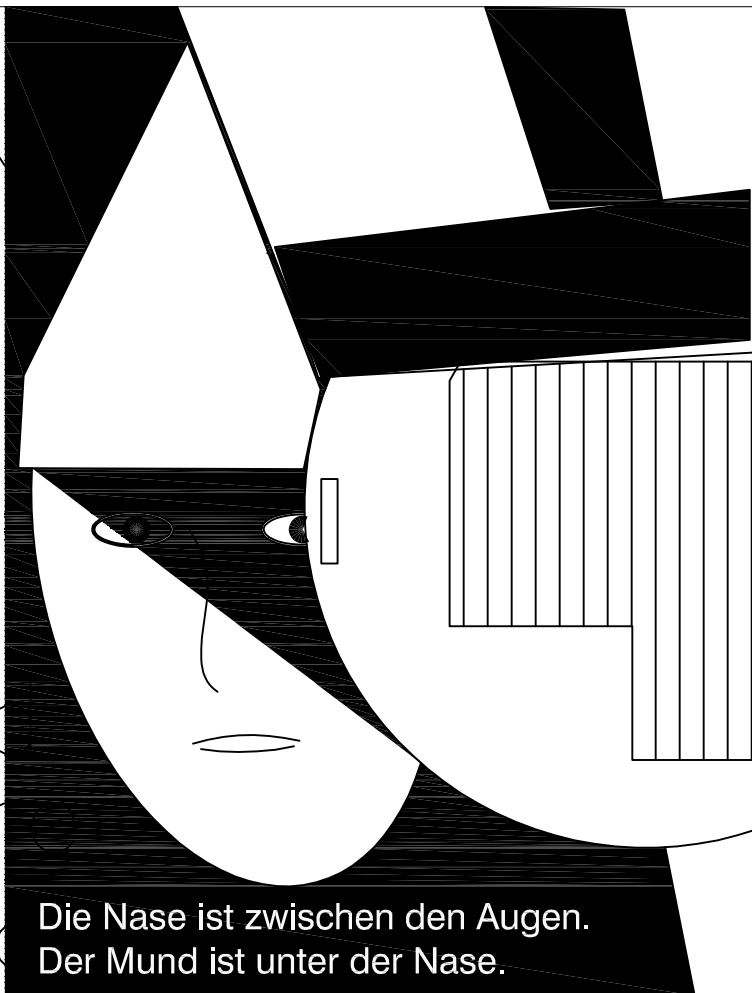

Die Nase ist zwischen den Augen.
Der Mund ist unter der Nase.

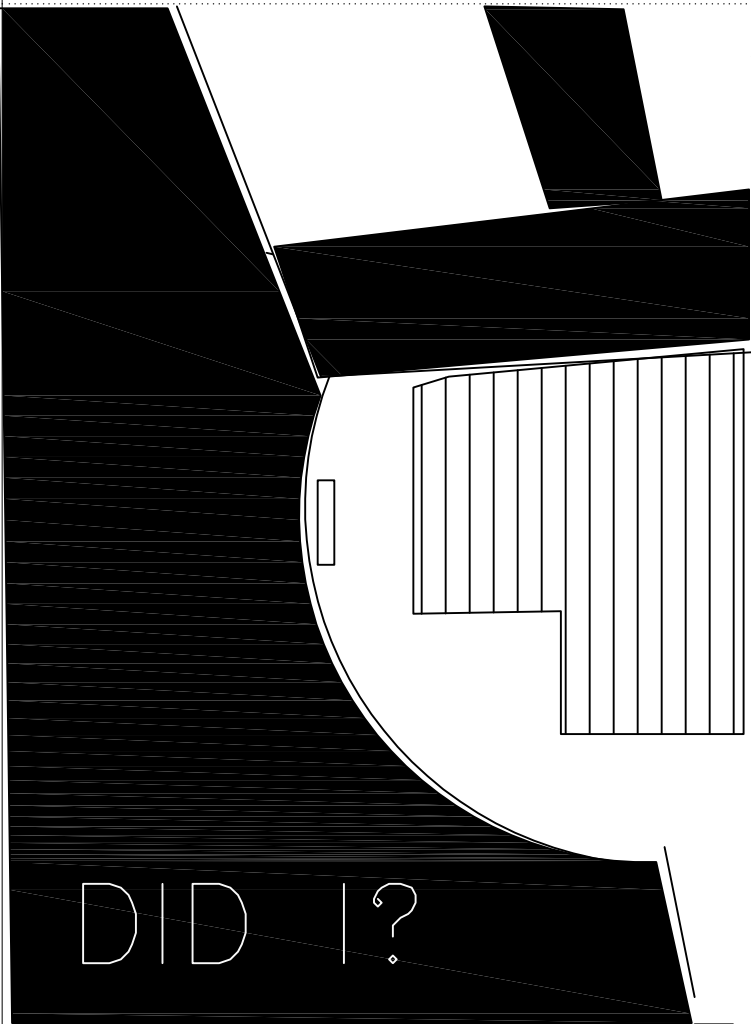

DID I?

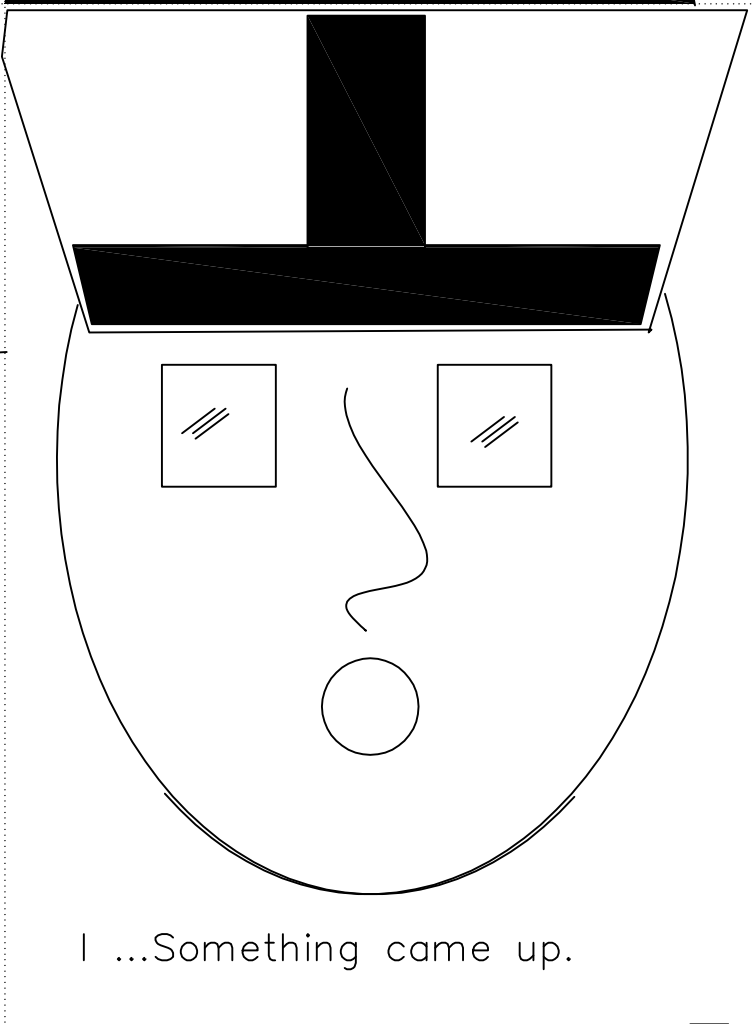

I ...Something came up.

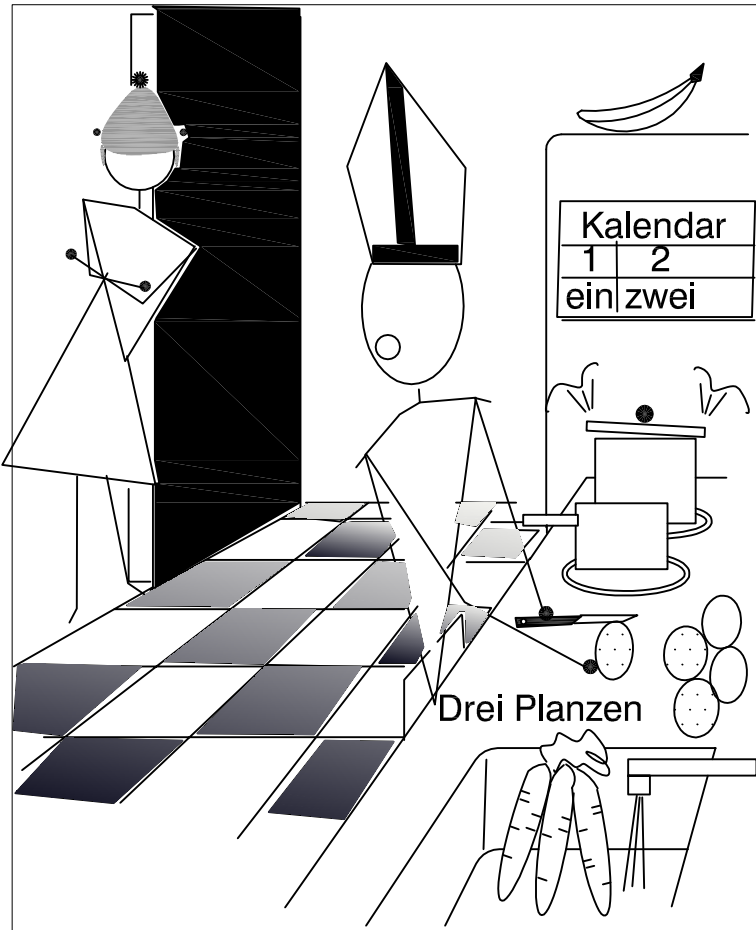

Relax.

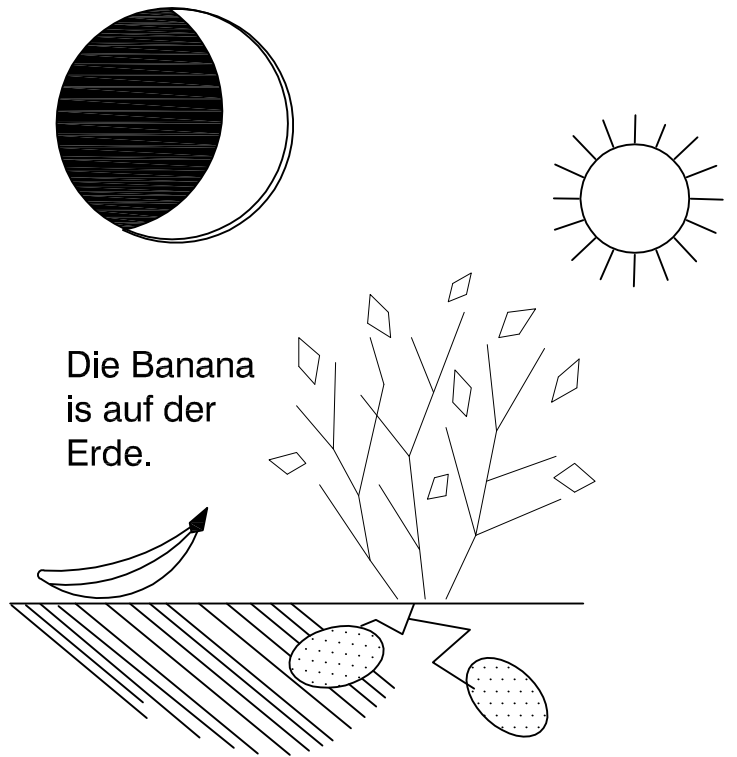

Die Banana
is auf der
Erde.

Die Kartoffeln ist
in der Erde.

We'll talk after dinner.

